

5 PAIRS 110 CONNECTING BLOCK

P/N: CBB05

S/N: C07-016

110 CONNECTING BLOCK, UTP, 5pairs,110 type.



Product picture

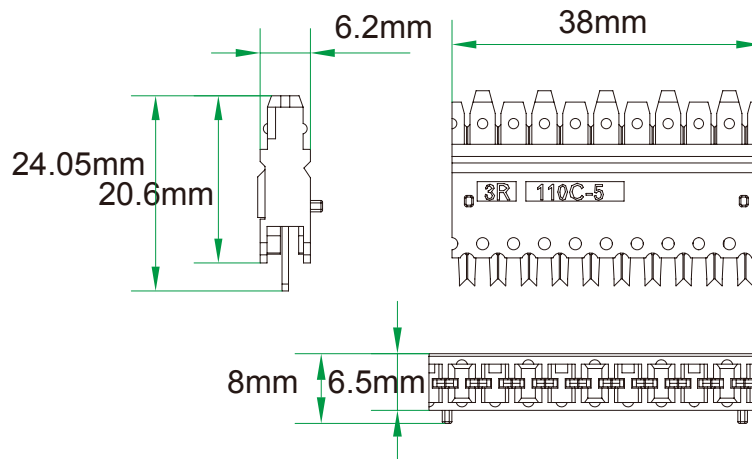

Structure chart

DESCRIPTION

Wall-mount 110 wiring blocks create compact, adaptable 110 termination field for voice and data by mounting 110 wiring bases to the wall or a backboard. Bases come in 50-, 100- or 300-pair densities. The 50-pair bases may be ordered with or without standoff legs which provide more room behind the base for cable.

APPLICATION

- Type : 50 pairs rack mount 110 wiring block
Available with legs or without legs to the wiring base
- Easy to adjust , easy to embed wires in
- Wiring blocks are designed to support voice and high-speed data application
- Offering a reliable and economical high -density system
- The terminal blocks accommodate 22-26 AWG with a insulation diameter of 0.4-0.64 mm
- IDC contact material : phosphor bronze with tin plating over nickel
Available with T568 A .T568 B wiring pattern

ORDER INFORMATION

Part number	Description	Standard Color	Inner box	Carton	Carton measurement	Carton weight
CBB05	5 pairs 110 connecting block	Beige	200PCS	2000PCS	L 53.5cm×W 31.3cm×H 23.4cm	11.50KG